

Rigel 266 *Plus*

Compact Electrical Medical Safety Analyser

Instruction Manual

350A555 Issue 1.1

February 2006

© 2006 Seaward Electronic Ltd.

Issue 1.1

Limited Warranty & Limitation of Liability

Rigel Medical, part of SEAWARD Electronic Limited guarantees this product for a period of 1 year. The period of warranty will be effective at the day of delivery.

© Copyright 2006

All rights reserved. Nothing from this edition may be multiplied, or made public in any form or manner, either electronically, mechanically, by photocopying, recording, or in any manner, without prior written consent from SEAWARD Electronic Limited. This also applies to accompanying drawings and diagrams.

Due to a policy of continuous development SEAWARD Electronic Limited reserves the right to alter the equipment specification and description outlined in this publication without prior notice and no part of this publication shall be deemed to be part of any contract for the equipment unless specifically referred to as an inclusion within such contract.

Table of Contents

Declaration of Conformity.....	5
Before Starting	6
Safety.....	7
CHAPTER 1 INTRODUCING THE ANALYSER	9
Introduction	9
Your compact medical safety analyser	10
The Top Panel.....	11
.....	12
The Keyboard.....	12
Definitions	13
CHAPTER 2 USING THE ANALYSER	15
Introduction	15
Controls.....	15
Display	15
Connecting the Analyser.....	18
Performing a Test.....	19
After a Test.....	20
Abort Actions	20
Printing Results	20
Equipment Type	21
Earth Continuity Tests	22
Insulation Tests	23
Powered Tests.....	25
Load Test	26

Earth Leakage Test	27
Earth Leakage, normal condition	29
Earth Leakage, single fault, supply open	30
Enclosure Leakage Test.....	30
Enclosure Leakage, normal condition	32
Enclosure Leakage, single fault, supply open	33
Enclosure Leakage, single fault, earth open	33
Patient Leakage - Applied Part To Earth	34
Patient Leakage, normal condition.....	36
Patient Leakage, single fault, supply open.....	37
Patient Leakage, single fault, earth open.....	37
Patient Leakage – F-Type	38
Patient Leakage – Mains on SIP/SOP	41
Patient Auxiliary Current	44
Patient Auxiliary, normal condition	46
Patient Auxiliary, single fault, supply open.....	47
Patient Auxiliary, single fault, earth open.....	47
IEC Lead Polarity Test	48
CHAPTER 3 MANUAL MODE	49
Operation:.....	49
CHAPTER 4 TIPS & TROUBLESHOOTING	53
Power On Self tests:	53
Safety Tests During Operation	55
Temperature monitoring.....	56
Interfacing.....	57
CHAPTER 5 MAINTAINING THE ANALYSER	59

Cleaning the Analyser	59
User Maintenance	59
CHAPTER 6 ACCESSORIES	62
Standard Accessories.....	62
Optional Accessories.....	62
CHAPTER 7 SPECIFICATIONS	63
AC Earth Bond Test.....	63
Insulation Test	63
Earth Leakage Test	63
Enclosure Leakage Test	64
Patient Leakage Test.....	64
Patient Auxiliary Test	64
Patient SIP/SOP Test.....	64
Patient F-Type Test.....	65
Load Test.....	65
IEC Lead Test	65
Mechanical	65
Environmental	65
APPENDIX	67
Test Limits.....	67
BS EN 60601 (IEC601) Leakage	67
Earth Bond and Insulation Tests	68
Earth Bond Continuity Limits	68
In-Service Insulation Limits	69

Declaration of Conformity

for the

Rigel 266 *Plus* Electrical Medical Safety Analyser

Manufactured by:

Seaward Electronic Ltd, Bracken Hill, South West Industrial Estate
Peterlee, County Durham, SR8 2SW, England

Millennium Statement

This product is Millennium compliant, and conforms fully to the document BSI DISC PD2000-1.

Statement of Conformity

Based on test results using appropriate standards, the product conforms with Electromagnetic Compatibility Directive 89/336/EEC and Low Voltage Directive 73/23/EEC

Standards used:

- EN 60601-1 (1990) Medical Electrical Equipment. General Requirements for Safety
- EN 61010-1 (1993) Safety Requirements for Electrical Equipment for Measurement, Control, and Laboratory Use
- EN 50081-1 (1992) Electromagnetic Compatibility. Generic Emission Standard: EN55022 Class B
- EN 50082-1 (1992) Electromagnetic Compatibility. Generic Immunity Standard: IEC1000-4-2, -4-3, -4-4, -4-5

The tests have been performed in a typical configuration.

This Conformity is indicated by the symbol , i.e. "Conformité Européenne"

Before Starting

Upon receipt of your Rigel-266 *Plus* Analyser:-

1. Check that all the component parts are present:-
 - *Rigel 266 plus* Analyser
 - Mains lead
 - Earth Bond lead
 - Applied Parts Lead
 - Applied Parts Adaptors (5 Off) & Crocodile Clip
 - Instruction Manual
 - Carrying Case
 - Calibration Certificate
2. Read the operating instructions fully before conducting any tests.
3. Contact Rigel Medical if you require training on this Analyser or any other Rigel Medical product. Courses can be arranged at Rigel Medical, or at customer premises.

4. Rigel Medical can be contacted at:

P/A Seaward Electronic Ltd
Bracken Hill
South West Industrial Estate
Peterlee, Co. Durham
SR8 2SW, England
Tel : +44 (0)191 587 8730
Fax: +44 (0)191 586 0227

sales@rigelmedical.com
calibration@seaward.co.uk

www.rigelmedical.com

Safety

Note

Please read the following Safety Instructions before use!



Safety Precautions

The manual contains specific warning and caution statements where they apply.

A Warning will identify the conditions and actions that pose hazard(s) to the user.

A Caution will identify the conditions and actions that may damage the Analyser.

Symbols used within this manual and on the Analyser are shown below:

	Risk of electric shock
	Warning of potential hazard
	Conformité Européenne

Use of the instrument in a manner not specified may impair safety. Read the following safety information carefully before attempting to operate the instrument.

**Warning**

Due to the potential hazards associated with any electrical circuit it is important that the user is familiar with the instructions covering the capabilities and operation of this instrument. The user should ensure that all reasonable safety precautions are followed and if any doubt exists should seek advice before proceeding.

This product is designed for use by suitably trained competent personnel and should be operated strictly in accordance with the instructions supplied.

Failure to comply with these instructions may expose the user to electrical hazard

This Analyser performs a number of electrical tests that involve high voltages and high currents. Never touch the appliance being tested, or the test leads, whilst a test is in progress.

Always check all test leads for signs of damage prior to use. Never use damaged or defective leads.

Always ensure the mains supply to the Analyser provides an adequate earth.

This manual contains information and warnings that must be heeded to ensure user safety during operation. It is essential that this manual is read fully before proceeding with any tests.

Should the Analyser behave abnormally do not continue with the testing. Disconnect immediately and contact Rigel Medical for servicing (see Chapter 4 - Maintaining the Analyser).

Chapter 1 Introducing the Analyser

Introduction

The Rigel-266 *plus* Electrical Medical Safety Analyser (EMSA) is a powerful tool to assist in the analysis of the safety of portable electrical and electronic medical equipment. A range of tests are provided, with innovative features to aid difficult test situations, which allow testing of a wide variety of equipment.

The Analyser combines state of the art testability with the following innovative features:-

- Truly portable analyser
- Accurate earth bond under all test situations
- Accurate leakage measurements
- Connects to printer to print results
- Large, easy to read digital display
- Easy test selection
- Full Manual control option
- Semi Automatic Test option

Your compact medical safety analyser

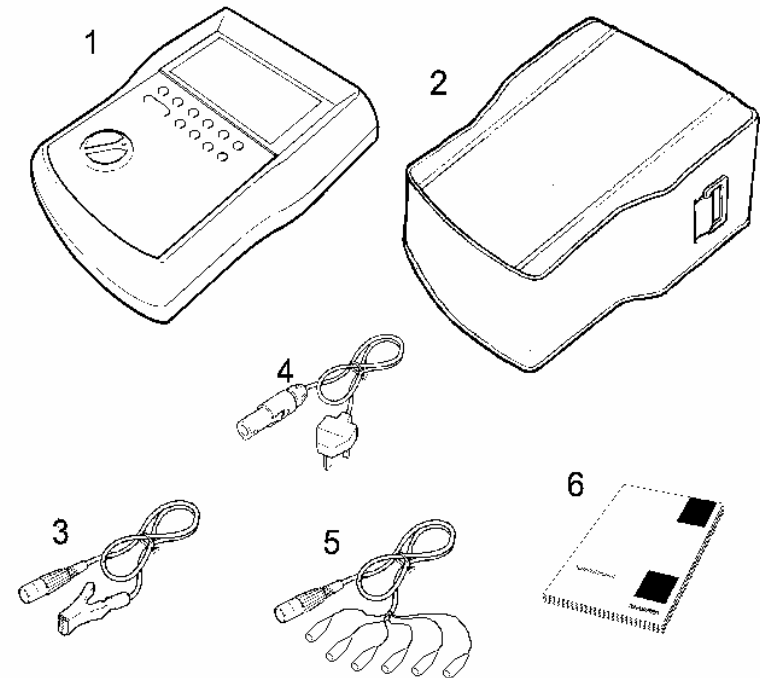

Item Number	Part
1	Rigel-266 <i>plus</i> EMSA
2	Carrying case
3	Earth Bond Lead
4	Power cord - Integral with the Rigel 266 plus
5	Applied Part Lead Set (including Applied Parts adaptors pack)
6	Manual

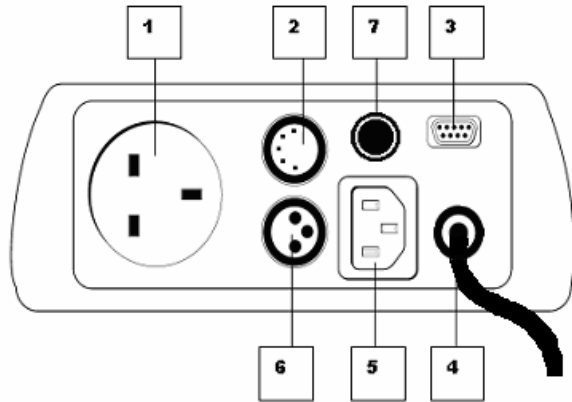

The Top Panel

Item Number	Part
1	EUT Mains Socket
2	Applied Parts Socket
3	Printer Interface
4	230V Mains Socket/Mains Input
5	IEC Lead Connector
6	Earth Bond Socket
7	SIP/SOP Socket

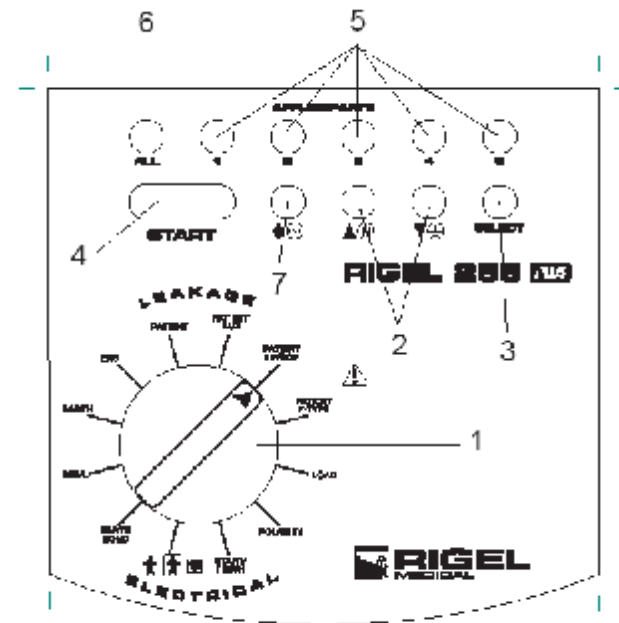

The Keyboard

Item	Part
1	Rotary Test Selection Switch
2	Semiautomatic Mode - Up Down Cursor keys Manual Mode [UP] – SFC Neutral Open, [DOWN] – SFC Earth Open, [DOWN] – SFC Mains on AP
3	Semiautomatic Mode - SELECT button Manual – AC-DC. Ac-Only & DC-Only Parameter
4	START / STOP button – start and stop tests
5	Applied Part Selection 1 – 5
6	Applied Part ALL Selection
7	Manual [DIAMOND] – Mains Normal / Reverse

The user is provided with a custom design Liquid Crystal Display (LCD). The keyboard consists of 10 push buttons to adjust the operating mode of the Analyser, and a larger push button to initiate tests. A rotary switch selects the test desired.

Definitions

EMSA-	Electrical Medical Safety Analyser Rigel 266 plus
EUT-	Equipment Under Test The electrical / electronic apparatus which is the subject of testing.
IUT-	Instrument Under Test Same as EUT
Applied Part -	Part of the EUT (including Patient leads) that comes into contact with a patient.
Powered Tests -	The EUT is supplied with mains voltage, with measurements being taken of power consumption, leakage currents etc.
Analyser / Tester -	The <i>Rigel 266 plus</i> compact medical electrical safety analyser.
Un-powered Tests -	The EUT is the subject of electrical tests using stimuli generated within the Analyser. The EUT is not provided with mains power.
User -	The test technician/operator using the Analyser to perform tests on a EUT.
Semiautomatic Mode -	The tester performs the SFC test automatically.
Manual Mode -	The User initiates the SFC tests.
Applied Part -	A part of the EUT that in normal use comes into contact with a patient.

- SFC - Single Fault Conditions. Neutral Open, Earth Open and Mains on AP are examples of Single Fault Conditions.
- F-Type Applied Part - An Applied Part isolated from other parts of the EUT to such a degree that under single fault conditions the patient leakage current is not exceeded.
- SIP/SOP - Signal Input/Signal Output. A part of the EUT intended to receive/deliver signal voltages or currents to/from other equipment (eg. RS232 serial port, data port for recording or data processing).
- Type B Applied Part - Applied part complying with specified requirements for protection against electric shock. Type B applied parts are those parts not suitable for direct cardiac application.
- Type BF Applied Part - F-Type Applied Part complying with a higher degree of protection against electric shock than type B applied parts. Type BF applied parts are those parts not suitable for direct cardiac application.
- Type CF Applied Part - F-Type Applied Part complying with a higher degree of protection against electric shock than type BF applied parts.

Chapter 2 Using the Analyser

Introduction

Controls

A rotary switch defines the basic test (or action) to be performed. The tests are arranged on the switch such that a clockwise rotation of the switch needed to perform a normal sequence of tests.

Arrow keys (\uparrow and \downarrow) allow for adjustment of test variables, e.g. of the test time. The Select key is used to change the variable to be adjusted.

The large START button is used to start a Test.

Display

Test Icons

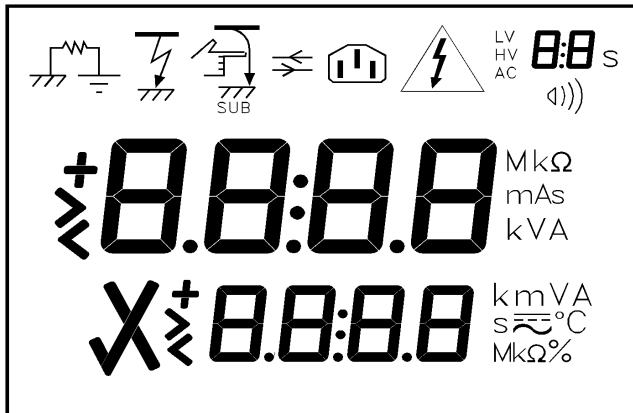





Primary Display

Secondary Display

The display consists of a number of Icons to provide visual indication of the Analyser status, a primary 4 digit, 7 segment display, along with a 4 digit secondary display, and a 2 digit duration time display.

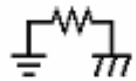
Test Icons

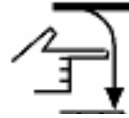
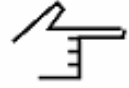
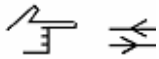
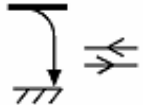
Indicates the test selected,

	Earth Continuity
	Insulation
	Earth Leakage
	Enclosure Leakage
	Patient Leakage
	Patient Auxiliary
	Load
	Polarity

Test in Progress Icon

Indicates test in progress with voltage warning.

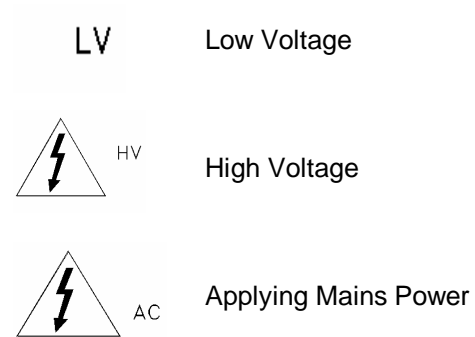

Test Duration Counter

Indicates the duration of the test. This will count down to zero. When the counter reaches zero. The test counter can be set to unlimited test duration (indicated by “UL” on the display). In this instance the counter will not count down and requires user intervention to stop the test being carried out. Note that the test duration is indication only.

Primary Display

Indicates test result and Equipment Class and Type. For some tests there is a minimum value displayed. If the measurement is below this “mask” value then the mask value is displayed indicating that the measured value is below the minimum indicated by the Analyser.

Secondary Display

Before a test, this display indicates test output e.g. voltage or current specified. During a test, this display may show the current step in the automatic test sequence. After a test, this display compares the test result with standard limits. During the leakage tests this displays the test being carried out in the test sequence. This is indicated as a text

mnemonic comprising of the mains power condition and the Single Fault Condition (SFC) present during the test.

For Patient Leakage and Patient Auxiliary tests two sets of sequences are carried out – one for ac only measurements and the other for dc only measurements as required by EN60601.

Connecting the Analyser

The Analyser must be powered by a 230V/115V supply (dependent on unit supplied). Check the rating label on the reverse of the unit for suitable mains voltage.

The supply to the Analyser must include an earth connection (e.g. via a 3 pin plug).

When switched on, the Analyser will carry out a short self-test procedure. Ensure the EUT is unconnected to the Analyser during the power on self-tests. During this test, all display segments will be lit to allow verification of correct operation of the display

Once the start-up procedure of the Analyser has been completed, the Analyser is ready for operation. The display will depend on the rotary knob position.

Performing a Test

Tests can be performed in two different ways i.e. in Semi-automatic mode or in Manual mode.

On power up the Analyser will be in Semi-automatic test mode. The user is required to select manual test mode from the Equipment Select rotary switch position. (See page 17)

For semi-automatic test mode all tests are performed in a similar way - Rotate the switch to the appropriate test. The test time will be flashing in the top left corner. Press the arrow keys to change the test time if required.

Pressing SELECT will cause the display to move to different parameters. Use the arrow keys to change the parameters as required.

Pressing SELECT will display the currently selected Equipment Class and Type if appropriate for that test. Press the arrow keys to change Equipment Class and Type if required.

If an Earth Continuity test is selected, and a different test current is required, press SELECT, which will cause the test current to flash and use the arrow keys to adjust the current as desired.

For many of the Patient Leakage tests, the user needs to select the appropriate Applied Part to be included in the test. To do this, press one of the buttons marked AP1 to AP5, or to select all the Applied Parts press the button marked ALL. The appropriate test will be applied to the corresponding Applied Part via the applied part harness.

When satisfied with the test conditions, press the START button to start the test.

Manual mode testing is limited to the leakage current tests: Earth Leakage, Enclosure Leakage, Patient Leakage, Patient Leakage – F-Type (Mains on AP), Patient Leakage SIP-SOP and Patient Auxiliary Current.

Rotate the switch to the appropriate leakage test. Select the required test conditions for EUT Mains power, Single Fault Conditions (SFC) and AC-DC, AC-Only or DC-Only parameters.

When satisfied with the test conditions, press the START button to start the test.

Once the power has been supplied to the EUT, the power will remain on the EUT between different positions within the Leakage Tests.

The user has the ability to perform a number of different leakage tests within a SFC, thus reducing the power-up and power-down cycles allowing for faster test routines.

Within all Patient Leakage measurements, different Patient Connections or Applied Parts can be selected using the [1..5, ALL] keys without causing a power break.

After a Test

In Semi-automatic test mode, after the Analyser completes the selected test, the measured value continues to be displayed until a button is pressed, or the rotary switch is turned to select a different test. The Secondary display provides a comparison with standard test values. A tick or cross may also be displayed indicating the success or failure of the test just performed.

Abort Actions

Whilst in semi-automatic mode, during a test, rotating the switch will stop the test. Whilst in manual test mode, pressing the stop key or rotating the test to non-leakage test (Earth Continuity, Insulation, Load or IEC Lead test) or will stop the test.

Printing Results

Rotating the switch to the **START / FINISH** position and pressing the START button will initiate printing the test results to a printer connected to the printer port.

After this has been done, all test results are then printed until the rotary switch is placed in the **START / FINISH** position again and the START button is pressed to initiate the final part of the results print-out.

The user is required to manually write such items as the appliance number, date etc, and to sign off the printout where necessary. It is also necessary for the user to manually determine whether the EUT has passed all tests.

Equipment Type



Rotating the switch to the equipment class and type symbols enables the user to select the class and type of the equipment to be tested. The display will indicate the current equipment type setting according to the following list:

- "I : b" – Class 1 Equipment with Type B Applied Parts.
- "I :bF" – Class 1 Equipment with Type BF Applied Parts.
- "I :cF" – Class 1 Equipment with Type CF Applied Parts.
- "II: b" – Class 2 Equipment with Type B Applied Parts.
- "II:bF" – Class 2 Equipment with Type BF Applied Parts
- "II:cF" – Class 2 Equipment with Type CF Applied Parts

By pressing the up/down arrows the user can cycle between different equipment class and types that will flash on the display. Pressing the SELECT key will cause the equipment type to stop flashing indicating that the equipment class and type had been selected.

During tests where the equipment class and type is displayed the operator has the opportunity of changing the equipment class and type selection by pressing the SELECT button. After pressing SELECT the arrow keys are used to cycle between the equipment class and types. Pressing SELECT again selects the current flashing option.

Other user settings can be set following selection of the equipment type. Following equipment selection, the user is also given the option to indicate the pass/fail limit or test sequence number when a leakage fails a given test limit ("PASS on"/"PASS off").

The user is given the option to enable or disable DC-Only tests for the Patient Leakage and the Patient Auxiliary Current tests during semi-automatic tests. The DC-Only is enabled from power up.

The user is given the option to enable the Manual Tests [SFC] for the leakage tests which includes Earth Leakage, Enclosure Leakage, Patient Leakage, Patient Leakage - Applied Part to Earth, Patient Leakage - F-Type, Patient Leakage - Mains on SIP/SOP and Patient Auxiliary Current.

Note: These settings are NOT stored in memory on powering down the Analyser.

Earth Continuity Tests

Switch Position ----- **Earth Bond**

Test Icon Displayed ---

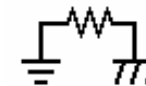

Class 1 (earthed) appliances

Plug EUT into Analyser outlet socket, connect the Earth Bond lead to the appliance metal part.

Class 2 (unearthed) appliances

This test cannot be performed as there is no earth connection to exposed conductive parts of the EUT. Pressing the Start button in this instance will not initiate the test.

If a different test current is required, press SELECT, which will cause the selected test current to flash, and use the arrow keys to select the appropriate current as desired.

This test is to ensure that the connection between the earth pin in the mains plug of the appliance and the metal casing of the appliance is satisfactory and of sufficiently low resistance.

The test current is applied between the earth pin of the mains supply plug and the earth bond test lead clip/probe.

A high current is normally used to stress the connection under fault conditions. The length of the test should be limited to prevent damage due to overheating. Tests currents of 1A, 10A and 25A AC are available.

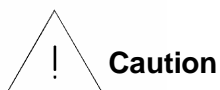

Prolonged use of the earth bond probe at high currents can lead to a high probe temperature. Care should be taken to avoid touching the probe tip under these conditions. The Analyser's internal over temperature switch may operate with prolonged repetitive use of high test currents. In this instance an error message will be displayed. In order to proceed with further tests the Analyser must be allowed to cool down.

Insulation Tests

Switch Position ----- **INSUL**

Test Icon Displayed ---



500V d.c. test voltage

Class 1 (earthed) appliances

Plug EUT into Analyser outlet socket

Class 2 (unearthed) appliances

Plug EUT into Analyser outlet socket, connect Earth Bond lead socket to the appliance.

This test is used to verify that the mains supply pins and applied parts are adequately insulated from earth.

During the insulation test, a 500V DC voltage is applied between the earth pin and both the live and neutral pins (EUT test selected) of the appliance mains supply plug or between all Applied Parts and Earth (AP test selected). The Analyser displays the insulation resistance measured.

The Analyser can test either the EUT by itself or all the Applied Parts internally connected together. Press the SELECT button and then press arrow keys to cycle between EUT and AP to change the mode of operation for the test.

For Class 2 appliances, the Earth Bond lead can be used for an earth return lead for the insulation test only.

The insulation test can be operated in "UL" unlimited test duration mode. In this case the test can be terminated by rotating the rotary switch.

Powered Tests



Warning

Mains voltage applied to appliance

The following powered tests differ from the previous tests in that they apply mains supply voltage to the appliance to perform their functions:-

- Load (Operation) Test
- Earth Leakage Test
- Enclosure Leakage Test
- Patient Leakage Test (AC & DC)
- Patient Auxiliary Test (AC & DC)
- F-Type – Mains on Applied Parts Tests
- SIP / SOP – Mains on Signal Input / Signal Output Test

The Analyser performs an initial low voltage test to establish that the appliance can be safely powered.



Warning

It is important that the user verifies that an appliance with moving parts is safely mounted to allow movement without causing damage to equipment or personnel.

If the potential load current is too high, a warning message appears, allowing the user to continue. This message will be displayed if a Live to Neutral short exists or the EUT mains current consumption is too high, and if tests are continued the Analyser's fuses will blow.

If the potential load current is low, a warning message appears to allow the user to check that the appliance is switched on, and all fuses are intact.

NOTE: If the measured value exceeds the values specified in BS EN 60601 the analyser will halt the automatic sequence. The user now has the option of proceeding with the remaining tests or aborting the sequence. To proceed with the remaining tests, press the START key, to abort press either the UP ARROW, DOWN ARROW or SELECT key.

The Analyser also performs an internal safety test to verify that internal relays are properly set before applying full mains supply to the appliance.

Load Test

Switch Position ----- **LOAD**

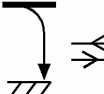
Test Icon Displayed --- 



Warning

Mains voltage applied to appliance

All Appliances

Plug EUT into Analyser outlet socket.

The Load test supplies the equipment under test (appliance), connected to 230V test sockets, with the rated voltage of that socket.

The Analyser measures the power used by the appliance and displays the reading in kVA. Power to the appliance can be set to remain on until the rotary switch is moved by selecting 'UL' unlimited test duration. This allows appliances with slow start-up speeds time to ramp up to their working state.

Earth Leakage Test

Switch Position ----- **EARTH**

Test Icon Displayed --- 



Warning

Mains voltage applied to appliance

NOTE: The Earth bond probe should not be used as part of these tests as this may affect the current being measured. Ensure the earth bond probe is disconnected from the EUT prior to running these tests.

All Appliances

Plug EUT into Analyser outlet socket.

The Earth Leakage Test shows the current being lost through Leakage. This is the current flow through the earth lead of the appliance, and displays the result in milliamps (mA).

To change the test duration, press the SELECT key and then UP or DOWN keys. The user can also select the type (B, BF, CF) by pressing SELECT again and then pressing the UP, DOWN keys.

The selection of normal and reverse operation and single fault conditions (neutral or earth open circuit) is done automatically during the test. The current test sequence step is shown on the lower display. Should a test fail, the Analyser will stop the automatic test sequence. The test sequence is shown below:

Test Sequence	Mains	Single Fault Condition
1. nor	Normal	None
EUT Power Break		
2. nP	Normal	Neutral Open
EUT Power Break		
3. rP	Reversed	Neutral Open
EUT Power Break		
4. rEv	Reversed	None

The user can press START at any time to start the test. During the test a screen showing test icon; test time countdown and test settings will be displayed.

This test can be set for “UL” unlimited test duration. In this mode the Start key initiates the first test in the automatic test sequence. This test will remain active until the Start key is pressed again at which point the supply to the EUT is switched off. The next test in the sequence can be activated by pressing the Start key. In this mode the Analyser allows for equipment with slow ramp up times to be tested.

The earth leakage tests are valid for Class I equipment with Types B, BF and CF applied parts.

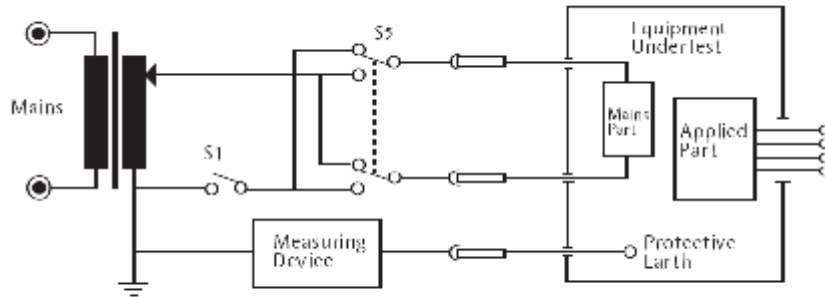

Diagram A - Test Circuit For Earth Leakage

The above diagram shows the test circuit used to measure the Earth leakage current.

Earth Leakage, normal condition

This test measures the earth leakage current under normal conditions. The current is measured through the Measuring Device with S1 closed and S5 normal and then S5 reversed. The maximum allowed values are as follows:

Type B	Type BF	Type CF
0.5 mA	0.5 mA	0.5 mA

Maximum allowed value

Earth Leakage, single fault, supply open

This test measures the earth leakage current with a single fault condition (supply open). The current is measured through the Measuring Device with S1 open and S5 in normal and then S5 reversed. The maximum allowed values are as follows:

Type B	Type BF	Type CF
1 mA	1 mA	1 mA

Maximum allowed value

Enclosure Leakage Test

Switch Position -----

ENC

Test Icon Displayed ---

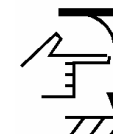

Warning

Mains voltage applied to appliance

All Appliances

Plug EUT into Analyser outlet socket and connect the earth bond probe to touch appliance metal part. For an EUT with SIP/SOP connections, link the SIP/SOP connections on the EUT and connect to the Analyser's SIP/SOP socket (**Note: A hazardous nominal 5mA current limited mains potential is applied at 110% of input mains**)

voltage to the SIP/SOP socket). For Class II equipment use the Earth Bond probe as a return path.

The Enclosure Leakage Test displays the current that would flow if a person touched the appliance. This is based on the standard IEC601 'body model'. The Analyser uses the earth bond probe to detect any current flowing on the appliance metalwork (attached to an appropriate point on the appliance) and indicates the potential leakage through a metal panel. The Analyser displays the result in milliamps (mA).

To change the test time value, press the SELECT key and then UP or DOWN keys. The user can also select the type (B, BF, CF) by pressing SELECT again and then pressing the UP, DOWN keys.

The selection of normal or reverse operation and single fault conditions (neutral or earth open circuit) is done automatically during the test. The current test sequence step is shown on the lower display. Should a test fail, the Analyser will stop the automatic test sequence. For Class II equipment, the Single Fault Earth Open tests are skipped. The test sequence is shown below:

Test Sequence		Mains	Single Fault Condition
Class I	Class II		
1. nor	1. nor	Normal	None
2. nE	*	Normal	Earth Open
EUT Power Break			
3. nP	2. nP	Normal	Neutral Open
EUT Power Break			
4. rP	3. rP	Reversed	Neutral Open
EUT Power Break			
5. rEV	4. rEV	Reversed	None
6. rE	*	Reversed	Earth Open

Note: Tests marked * are not performed for Class II equipment.

The user can press START at any time to start the test. During the test a screen showing test icon, test time countdown and test settings will be displayed. If unlimited test duration is selected the user must press the Start key to stop the test, and press Start again to initiate the next step in the test sequence.

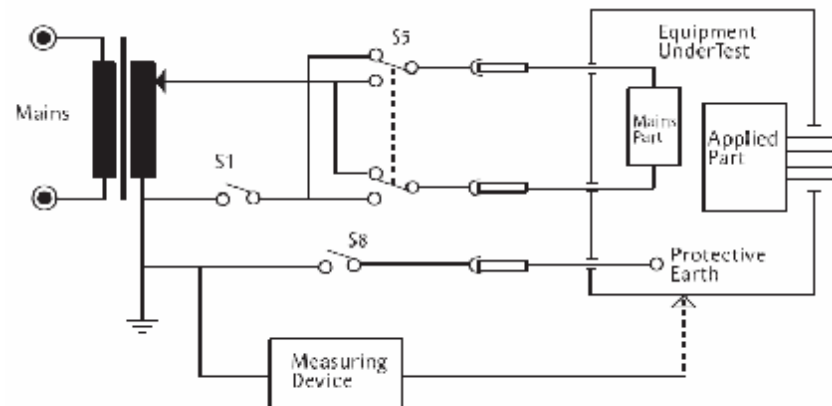

Diagram B - Test Circuit For Enclosure Leakage

For enclosure leakage tests the earth bond probe is used to make contact with all conductive non-protectively earthed parts of the equipment.

Enclosure Leakage, normal condition

This test measures the enclosure leakage current under normal conditions. The current is measured through the Measuring Device with S1 and S8 closed and S5 normal and reversed. The maximum allowed values are as follows:

	Type B	Type BF	Type CF
Class I	0.1 mA	0.1 mA	0.1 mA

Enclosure Leakage Test

Class II	0.1 mA	0.1 mA	0.1 mA
----------	--------	--------	--------

Enclosure Leakage, single fault, supply open

This test measures the enclosure leakage current with a single fault condition (supply open). The current is measured through the Measuring Device with S1 open, S8 closed and S5 in normal and then S5 reversed. The maximum allowed values are as follows:

	Type B	Type BF	Type CF
Class I	0.5 mA	0.5 mA	0.5 mA
Class II	0.5 mA	0.5 mA	0.5 mA

Enclosure Leakage, single fault, earth open

This test measures the enclosure leakage current with a single fault condition (earth open). The current is measured through the Measuring Device with S1 closed, S8 open and S5 in normal and then S5 reversed. The maximum allowed values are as follows:

	Type B	Type BF	Type CF
Class I	0.5 mA	0.5 mA	0.5 mA
Class II	n/a	n/a	n/a

Patient Leakage - Applied Part To Earth

Switch Position ----- **PATIENT**

Test Icon Displayed --- 



Mains voltage applied to appliance. This test involves applying a current limited mains potential (110% of mains input voltage) to the SIP/SOP socket. Due to the requirements for EN60601 testing this test current can be in excess of 5mA under short circuit conditions and as such is hazardous to the user. Caution should be taken when conducting this test. Current limiting is via a limiting resistor in series with the SIP/SOP socket.

NOTE: The Earth bond probe should not be used as part of these tests as this may affect the current being measured. Ensure the earth bond probe is disconnected from the EUT prior to running these tests.

All Appliances

Plug EUT into Analyser outlet socket, use Applied Parts lead from the Applied Part socket and attach the applied parts from the EUT to the Analyser (Use Applied Parts adaptors, where necessary).

The Patient Leakage Test displays the current that would flow if an Applied Part was attached on a person. The Analyser detects any current flowing in the Applied Parts Lead. The Analyser displays the result in milliamps (mA).

To change the test duration, press the SELECT key and then UP or DOWN keys. The user can also select the type (B, BF, CF) by pressing SELECT again and then pressing the UP, DOWN keys.

The user must select the applicable Patient Connection or Applied Part prior to commencing the test. When the test duration is set to UL (unlimited), the user can toggle between different Patient Connections as required to take the individual measurements.

The selection of normal or reverse operation and single fault conditions (neutral or earth open circuit) is done automatically during the test. The current test sequence step is shown on the lower display. Should a test fail, the Analyser will stop the automatic test sequence. For Class II equipment, the Single Fault Earth Open tests are skipped. The Analyser will first perform the automatic test sequence for AC-only measurement as required by IEC-601, then if enabled repeat the test sequence for the DC-only measurement. The test sequence is shown below:

Test Sequence		Mains	Single Fault Condition
Class I	Class II		
1. nor	1. nor	Normal	None
2. nE	*	Normal	Earth Open
EUT Power Break			
3. nP	2. nP	Normal	Neutral Open
<i>EUT Power Break</i>			
4. rP	3. rP	Reversed	Neutral Open
EUT Power Break			
5. rEV	4. rEV	Reversed	None
6. rE	*	Reversed	Earth Open

Note: Tests marked * are not performed for Class II equipment.

If the unlimited test duration is selected the user must press the Start key to stop the test. To initiate the next test in the sequence the Start key must be pressed again. In this mode the Analyser can be used to test equipment with slow start-up speeds.

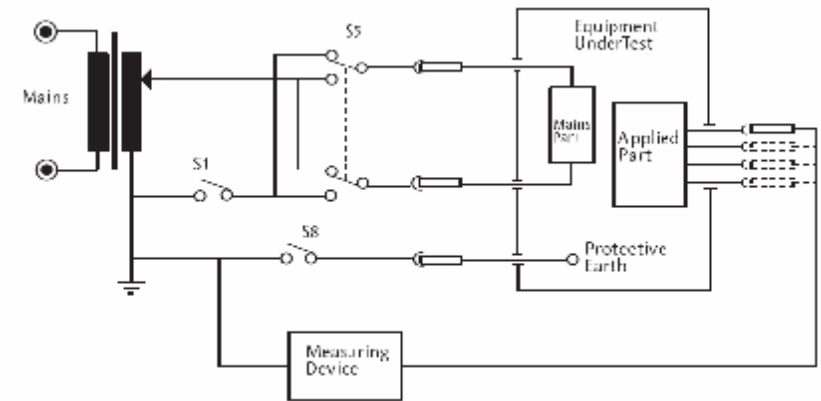

Diagram C - Test Circuit For Patient Leakage Current

For type B and BF equipment, the patient leakage current is measured with all parts of the applied part connected together, shown dotted above. For type CF equipment the patient leakage current is measured from each part of the applied lead separately. IEC601-1 amendment 2 specifies separate maximum allowed values for AC and DC current - both of which are measured by the Safety Analyser.

Patient Leakage, normal condition

This test measures the patient leakage current under normal conditions. The current is measured through the Measuring Device with S1 and S8 closed, S5 normal and then S5 reversed. The maximum allowed values are as follows:

	Type B	Type BF	Type CF
Class I DC	0.01 mA	0.01 mA	0.01 mA
AC	0.1 mA	0.1 mA	0.01 mA
Class II DC	0.01 mA	0.01 mA	0.01 mA
AC	0.1 mA	0.1 mA	0.01 mA

Patient Leakage, single fault, supply open

This test measures the enclosure leakage current with a single fault condition (supply open).

The current is measured through the Measuring Device with S1 open, S8 closed and S5 normal and then S5 reversed. The maximum allowed values are as follows:

	Type B	Type BF	Type CF
Class I DC	0.05 mA	0.05 mA	0.05 mA
AC	0.5 mA	0.5 mA	0.05 mA
Class II DC	0.05 mA	0.05 mA	0.05 mA
AC	0.5 mA	0.5 mA	0.5 mA

Patient Leakage, single fault, earth open

This test measures the patient leakage current with a single fault condition (earth open). The current is measured through the Measuring Device with S1 closed, S8 open and S5 normal and then S5 reversed. The maximum allowed values are as follows:

	Type B	Type BF	Type CF
Class I DC	0.05 mA	0.05 mA	0.05 mA
AC	0.5 mA	0.5 mA	0.05 mA
Class II	n/a	n/a	n/a

Patient Leakage – F-Type

Switch Position ----- **PATIENT F-TYPE**

Test Icon Displayed --- 



This test involves applying a current limited mains potential (110% of mains input voltage) to the Applied Parts connections. Due to the requirements for EN60601 this test current can be in excess of 5mA under short circuit conditions and as such is hazardous to the user. Caution should be taken when conducting this test. Current limiting is via a limiting resistor in series with the measurement circuit.

NOTE: The Earth bond probe should not be used as part of these tests as this may affect the current being measured. Ensure the earth bond probe is disconnected from the EUT prior to running these tests.

All Appliances

Plug EUT into Analyser outlet socket, connect the Applied Parts lead from the Applied Part socket and attach the applied parts from the EUT to the lead.

The Patient Leakage F-Type Test (also known as mains on Applied Parts test) displays the current that would flow if a mains potential was applied to the Applied Part which was attached to a patient (i.e. a single fault condition). The Analyser detects any current flowing in the Applied Parts Lead (attached to an appropriate point on the appliance). This test is applied only to type BF and CF equipment. The Analyser displays the result in milliamps (mA).

Patient Leakage – F-Type

To change the test duration, press the SELECT key and then UP or DOWN keys. The user can also select the type (BF, CF) by pressing SELECT again and then pressing the UP, DOWN keys.

The user must select the applicable Patient Connection or Applied Part prior to commencing the test. When the test duration is set to UL (unlimited), the user can toggle between different Patient Connections as required to take the individual measurements.

The selection of normal or reverse operation and single fault conditions (neutral or earth open circuit) is done automatically during the test (with the exception of the earth bond probe which is internally connected to earth during the entire test sequence). The current test sequence step is shown on the lower display. Should a test fail, the Analyser will stop the automatic test sequence. For Class II equipment, the Single Fault Earth Open tests are skipped. The test sequence is shown below:

Test Sequence	Mains	Single Fault
Class I / 2		Condition
1. nS	Normal	Mains on AP – Normal
2. nSr	Normal	Mains on AP – Reversed
EUT Power Break		
3. rS	Reversed	Mains on AP – Normal
4. rSr	Reversed	Mains on AP – Reversed

The user can select unlimited test duration. In this instance the user must press the Start button to stop testing. The Start button must be pressed again to initiate the next test in the test sequence.

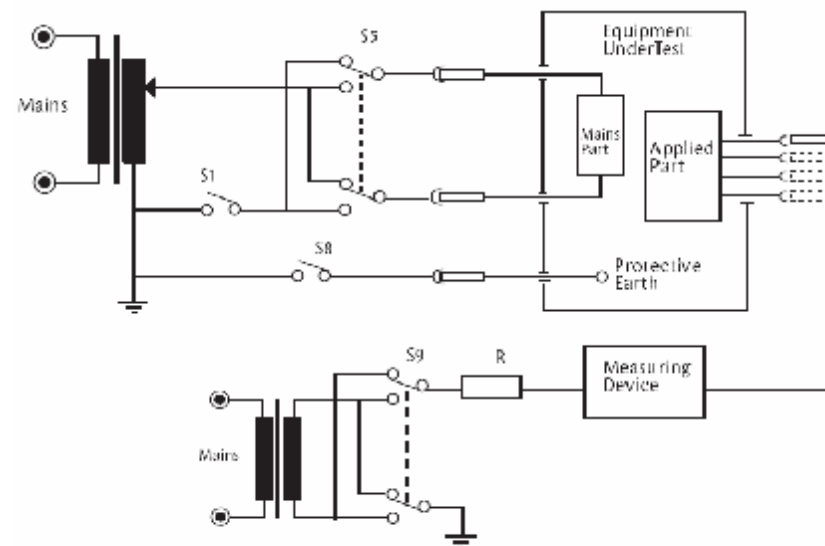

Diagram D - Test Circuit For Patient Leakage Current, Mains On Applied Part

For type BF equipment the patient leakage current is measured with all parts of the applied part connected together, shown dotted above. For type CF equipment the patient leakage current is measured from each part of the applied part separately (as selected by the AP1-5 keys). Each reading must not exceed the maximum allowed value.

The current is measured through the Measuring Device with S1 closed, S8 closed and S5 and S9 normal and then S9 reversed. The maximum allowed values are as follows:

	Type B	Type BF	Type CF
Class I	n/a	5 mA	0.05 mA
Class II	n/a	5 mA	0.05 mA

Patient Leakage – Mains on SIP/SOP

Switch Position ----- **PATIENT SIP/SOP**

Test Icon Displayed --- 

Warning 

Mains voltage applied to appliance. This test involves applying a current limited mains potential (110% of mains input voltage) to the SIP/SOP Analyser socket. Due to the requirements for EN60601 testing this test current can be in excess of 5mA under short circuit conditions and as such is hazardous to the user. Caution should be taken when conducting this test. Current limiting is via a limiting resistor in series with the SIP/SOP socket.

NOTE: The Earth bond probe should not be used as part of these tests as this may affect the current being measured. Ensure the earth bond probe is disconnected from the EUT prior to running these tests.

All Appliances

Plug EUT into Analyser outlet socket, use Applied Parts lead from the Applied Part socket and attach the applied parts from the EUT to the Analyser. Common the SIP/SOP connections on the EUT and connect to the Analyser SIP/SOP socket.

The Patient Leakage caused by an external voltage on a Signal Input or Signal Output (SIP/SOP) part (also known as mains on SIP/SOP test) displays the current that would flow if an Applied Part was attached to a patient and a mains potential was applied to the SIP/SOP parts of the equipment (i.e. a single fault condition). The Analyser detects any current flowing in the Applied Parts Lead (attached to an appropriate point on the appliance). This test applies only to type B equipment. The Analyser displays the result in milliamps (mA).

To change the test duration, press the SELECT key and then the UP or DOWN keys. This test applies to Type B equipment only.

The selection of normal or reverse operation and single fault conditions (neutral or earth open circuit) is done automatically during the test (with the exception of the earth bond probe which is internally connected to earth during the entire test sequence). The current test sequence step is shown on the lower display. Should a test fail, the Analyser will stop the automatic test sequence. For Class II equipment, the Single Fault Earth Open tests are skipped. The test sequence is shown below:

Test Sequence	Mains	Single Fault
1. nS	Normal	Mains on SIP/SOP – Normal
2. nSr	Normal	Mains on SIP/SOP – Reversed
3. rS	Reversed	Mains on SIP/SOP – Normal
4. rSr	Reversed	Mains on SIP/SOP – Reversed

This test can be operated in unlimited test duration mode. In this mode of operation the Start key must be pressed to stop the current test, and pressed again to initiate the next test in the test sequence. In this manner equipment with slow start-up times can be tested.

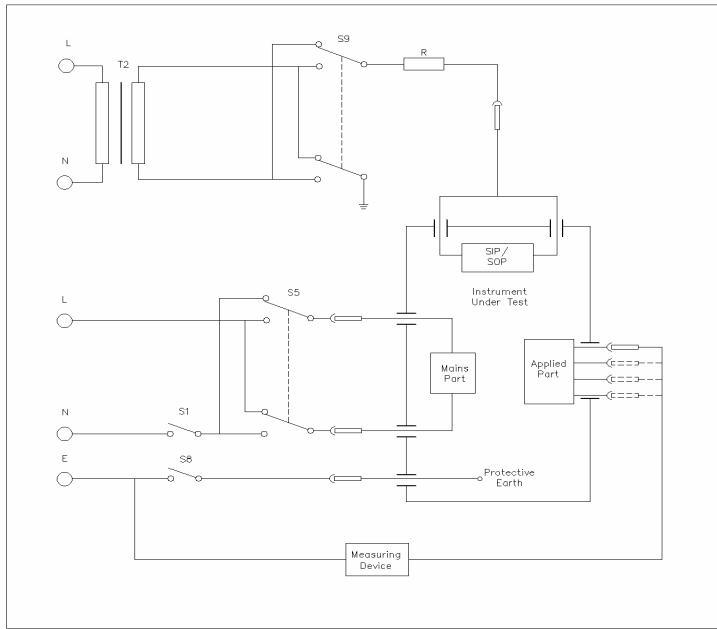

Test Circuit for Patient Leakage Current, Mains or Signal Input or Signal Output (SIP/SOP)

For type B equipment the patient leakage current is measured with all parts of the applied part connected together, shown dotted above.

The current is measured through the Measuring Device with S1 closed, S8 closed and S5 and S9 normal and then S9 reversed. The maximum allowed values are as follows:

	Type B	Type BF	Type CF
Class I	5 mA	n/a	n/a
Class II	5 mA	n/a	n/a

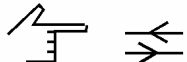
Patient Auxiliary CurrentSwitch Position ----- **PATIENT AUX**Test Icon Displayed --- **Warning****Mains voltage applied to appliance**

NOTE: The Earth bond probe should not be used as part of these tests as this may affect the current being measured. Ensure the earth bond probe is disconnected from the EUT prior to running these tests.

All Appliances

Plug EUT into Analyser outlet socket, connect the Applied Parts lead to the Applied Part socket and attach the applied parts from the EUT to the lead.

The Patient Auxiliary Current displays the leakage current that would flow between Applied Parts under normal and fault conditions. The Analyser detects any current flowing between one Applied Part and the remaining Applied parts shorted together. The Analyser displays the result in milliamps (mA).

To change the test duration, press the SELECT key and then UP or DOWN keys. The user can also select the type (B, BF, CF) by pressing SELECT again and then pressing the UP, DOWN keys.

The user must select the applicable Patient Connection or Applied Part prior to commencing the test. When the test duration is set to UL (unlimited), the user can toggle between different Patient Connections as required to take the individual measurements.

The Rigel 266 plus will measure the Auxiliary Leakage current between the selected Applied Part to the other, shorted automatically.

The selection of normal or reverse operation and single fault conditions (neutral or earth open circuit) is done automatically during

Patient Auxiliary Current

the test. The current test sequence step is shown on the lower display. Should a test fail, the Analyser will stop the automatic test

sequence. For Class II equipment, the Single Fault Earth Open tests are skipped. The Analyser will first perform the automatic test sequence for AC-only measurement as required by IEC-601, then if enabled repeat the test sequence for the DC-only measurement. The test sequence is shown below:

Test Sequence		Mains	Single Fault Condition
Class I	Class II		
1. nor	1. nor	Normal	None
2. nE	*	Normal	Earth Open
EUT Power Break			
3. nP	2. nP	Normal	Neutral Open
EUT Power Break			
4. rP	3. rP	Reversed	Neutral Open
EUT Power Break			
5. rEV	4. rEV	Reversed	None
6. rE	*	Reversed	Earth Open

Note: Tests marked * are not performed for Class II equipment.

This test can be operated in unlimited test duration mode. In this mode of operation the Start key must be pressed to stop the current test, and pressed again to initiate the next test in the test sequence. In this manner equipment with slow start-up times can be tested.

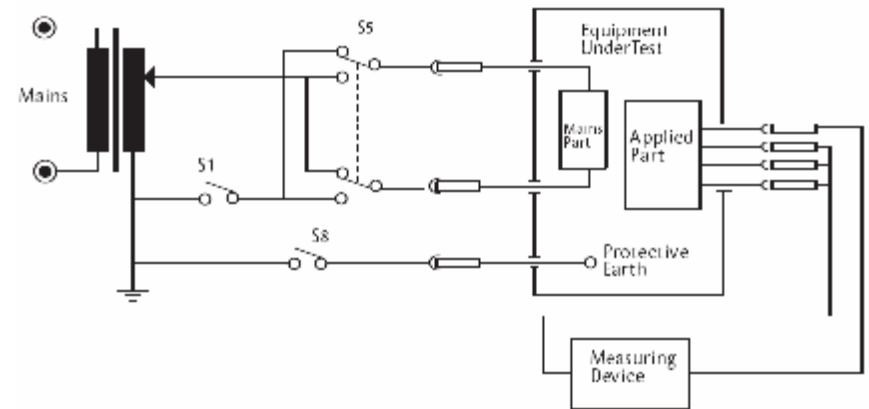

Diagram E - Test Circuit For Patient Auxiliary Current

For these tests, current is measured between a single part of the applied part and all other applied parts connected together. This test should be repeated until all combinations have been tested. IEC601-1 specifies separate maximum allowed values for AC and DC current - both of which are measured.

Patient Auxiliary, normal condition

This test measures the patient auxiliary current under normal conditions. The current is measured through the Measuring Device with S1 and S8 closed, S5 normal and then S5 reversed. The maximum allowed values are as follows:

	Type B	Type BF	Type CF
Class I DC	0.01 mA	0.01 mA	0.01 mA
AC	0.1 mA	0.1 mA	0.01 mA
Class II DC	0.01 mA	0.01 mA	0.01 mA
AC	0.1 mA	0.1 mA	0.01 mA

Patient Auxiliary, single fault, supply open

This test measures the patient auxiliary current under a single fault condition (supply open). The current is measured through the Measuring Device with S1 open, S8 closed and S5 normal and then S5 reversed. The maximum allowed values are as follows:

	Type B	Type BF	Type CF
Class I DC	0.05 mA	0.05 mA	0.05 mA
AC	0.5 mA	0.5 mA	0.05 mA
Class II DC	0.05 mA	0.05 mA	0.05 mA
AC	0.5 mA	0.5 mA	0.5 mA

Patient Auxiliary, single fault, earth open

This test measures the patient auxiliary current under a single fault condition (earth open). The current is measured through the Measuring Device with S1 closed, S8 open and S5 normal and then S5 reversed. The maximum allowed values are as follows:

	Type B	Type BF	Type CF
Class I DC	0.05 mA	0.05 mA	0.05 mA
AC	0.5 mA	0.5 mA	0.05 mA
Class II	n/a	n/a	n/a

IEC Lead Polarity Test

Switch Position ----- **POLARITY**

Test Icon Displayed --- 



40Va.c. test voltage applied to lead

Plug the lead into the Analyser outlet socket, and also into the Analyser IEC socket.

The IEC test performs a continuity and polarity check on the **Live** and **Neutral** conductors and confirms that there are no breaks or cross wiring in these conductors.

Note: Earth Bond and Insulation tests also need to be made to confirm the electrical safety of IEC leads.

Chapter 3 Manual Mode

Operation:

Manual Mode is selected from the Equipment Type menu.

During Manual Mode testing the user controls the operation of the Single Fault Conditions (SFC), the polarity of the mains power (normal or reversed), the selection of Applied Parts (AP) and the selection of AC-DC, AC-Only and DC-Only parameters.

The user can select the SFC, mains polarity and AC / DC parameter before initiating a test. The user presses the START to begin the test.

Power is maintained to the EUT even when the user changes the SFC or when an Applied Part is changed or an AC-DC, AC-Only and DC-Only parameters is changed.

During the manual mode when mains power is applied to the EUT the hazard symbol is displayed.

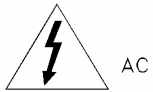

To cancel or abort the test when running the user press the START button or rotates the rotary switch to a non-leakage test such as Earth Continuity, Insulation, Load, IEC test, Equipment Type or Print Results.

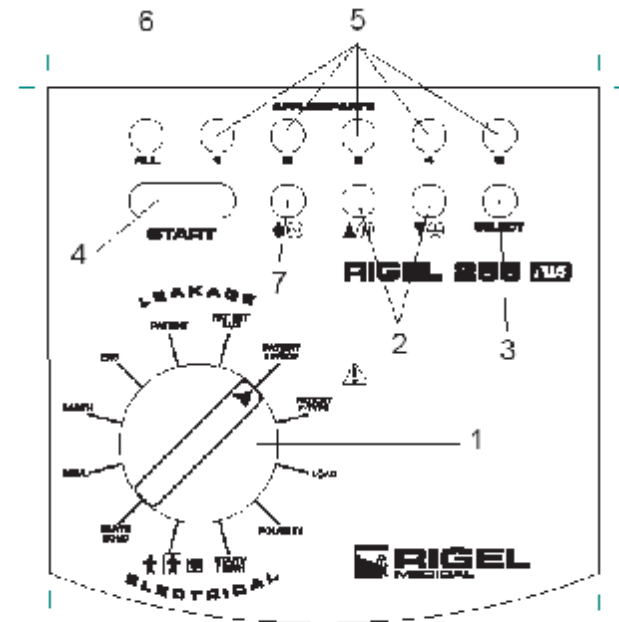

Item Number	Part
1	Rotary Test Selection Switch
2	Manual [UP] – SFC Neutral Open Manual [DOWN] – SFC Earth Open Manual [DOWN] – SFC Mains on AP
3	Manual – AC-DC. Ac-Only & DC-Only Parameter
4	START / STOP button – start and stop tests
5	Applied Part Selection 1 – 5

Operation:

6	Applied Part ALL Selection
7	Manual [DIAMOND] – Mains Normal / Reverse

Below a table with the applicable test conditions for testing in accordance with IEC 60601-1 and other equivalent standards. These Single Fault Conditions are in addition to the standard measurements and are to be tested under normal and reversed mains power.

Leakage Test	SFC				
	Neutral Open	Earth Open	Mains on AP	Mains on SIP/SOP	AP
Earth	Yes	No	No	No	No
Enclosure	Yes	Yes	No	No	No
Patient	Yes	Yes	No	No	Yes
Patient – F-Type	No	No	Yes	No	Yes
Patient – SIP/SOP	No	No	No	Yes	Yes
Patient Auxiliary	Yes	Yes	No	No	Yes

The polarity of the Mains Power can be changed during any test. When reversing the mains power, the EUT supply will be interrupted for a short period.

The selection of AC-DC, AC-Only or DC-Only parameters can be changed during any test by pressing the Select Key [3].

During a test only one SFC is allowed. Should the user select another SFC when a SFC is already being performed, the existing SFC will be cancelled and replaced by the new SFC by pressing the Up/Down & Diamond keys [2].

During Manual Mode tests no Pass or Fail limits are displayed.

The user is able to select the required Patient Connections or applied Parts by using the selection keys 1...5, ALL [5&6]

Chapter 4 Tips & Troubleshooting

Power On Self tests:

When the Analyser is powered on, a number of messages can possibly appear as the Analyser performs safety tests on itself and the mains power supply. If a fault is identified, the primary (large) display will scroll a message across the 4 digits, while the secondary display shows an error number.

If any of the self tests fail, then one of the following displays will be seen.

INTERNAL FAULT

Err1

or **Err4**

An ERR1 message will appear when the Rigel 266 plus is powered on with either an EUT connected to the EUT socket, an earthed perifiral connected to the RS232 port or when the earthbnd probe is connected to an earthed EUT.

Other possible causes are; By the Analyser's internal over temperature switch if prolonged earth bond tests have previously been carried out. Allow the Analyser to cool down before re-powering the Analyser. Alternatively if the EUT is plugged into the Analyser during the *Rigel 266 plus* power-up sequence this may affect the internal relay test that checks for correct operation of the internal Neutral relay used on leakage tests. Disconnect all test leads and re-power the Analyser. If the problem persists return the unit to Rigel Medical for correction of the fault.

If a voltage greater than 30V is detected on the neutral input line or the earth is missing then the following display will be seen.

L N REVERSED

Err2

Check for incorrect wiring at the power source. The user can proceed by pressing the START button if it has been established that it is safe to do so. The Analyser will automatically auto correct.

The next test checks the Analyser's internal neutral line relay, as used on the Leakage tests. In order to test for this the Analyser "floats" the internal measurement circuit and compares the voltage to earth when the neutral relay should be open and closed. If the internal neutral relay is shorted or open circuit then the following message may be displayed:

NEUTRAL FAULT

Err9

In addition to a genuine relay fault this message may also be caused by the internal measurement circuit being grounded via any external test leads (including serial lead, EUT power lead) that are connected to the *Rigel 266 plus*. The user can proceed by pressing the START button to ignore this message only if it is safe to do so. Alternatively remove the power from the *Rigel 266 plus* and disconnect all leads from the Analyser before re-powering the unit. If the problem persists the *Rigel 266 plus* may be faulty, contact Rigel Medical for repair.

The next test will check for an earth connection. If there is no Earth connection to the Analyser, the following display will be seen.

FLOATING EARTH

Err3

Check for incorrect wiring on the power supply.

The Analyser will fail the voltage on neutral check if it is being supplied with a balanced supply (e.g. 115V - 0 - 115V) since it will detect phase voltage on both L and N supply connections. **Only continue if it is certain that the supply is balanced and the earth on the Analyser connection is secure.**

NOTE: When measuring on a Non TN system (ie Neutral not Grounded), the measurements might be lower than when performed on a TN system as the Live to Earth voltage is lower

than the Live – Neutral voltage thus resulting in a potential lower leakage current.

If all of the above have been checked, the *Rigel 266 plus* may be faulty - contact Rigel Medical for repair.

Safety Tests During Operation

The Analyser performs self-tests during normal operation. An internal earth bond test and a low voltage test are performed prior to applying mains power to any EUT (including Load/Leakage and Patient Leakage tests).

If the internal earth bond test fails, the following message will be seen:-

INTERNAL FAULT

Err4

This may be caused by the Analyser's internal over temperature switch if prolonged earth bond tests have previously been carried out. If the problem persists the *Rigel 266 plus* is faulty and requires repair. Return the unit to Rigel Medical for correction of the fault.

If the low voltage test fails, then either of the following warnings will be displayed:-

LOAD TOO GREAT

Err5

It is possible that the appliance under test will draw more than 18A and could therefore damage the *Rigel 266 plus*. User discretion is required. If in doubt do not test and seek advice.

Temperature monitoring

The Analyser is provided with internal temperature monitors to ensure sensitive components are not overheated. High rates of testing may cause this situation, especially with a series of long duration Earth Continuity tests. Setting Earth Continuity test duration to 2 seconds will increase operating time. If the following message appears, leave the Analyser to cool down before pressing Enter to continue testing.

HOT
Err7

Interfacing

The Analyser provides a single 9 way connector for a serial interface to Rigel Medical's optional serial printer.

Note: Rigel Medical only recommend the use of Rigel Medical approved printers. The use of alternative printers to those supplied by Rigel Medical may impair the performance of the Rigel 266 plus. Connection to other earthed peripherals (ie laptops and PC's) will effect the reading of the Rigel 266 plus.

An option Blue Tooth RS 232 adaptor is allow for real time download to earthed peripherals (ie Laptops & PC's). Please contact our sales department for further information.

When using the Rigel Medical Thermal Printer (model MCP9810) the printer's DIP switch settings should be set to SW1-3 on, SW4 off, SW5-8 on. Ensure the printer is fully charged before use with the *Rigel 266 plus* as erroneous operation may result. See separate MCP9810 printer manual for details.

The Connector pin-outs for the Serial port are shown below for information only:-

Serial Port

The serial port uses a standard 9-way D-type connector

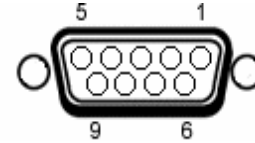

Pin	Description
1.	N.C.
2.	RX
3.	TX
4.	DTR
5.	0V
6.	N.C.
7.	0V
8.	N.C.
9.	+5V

Baud Rate: 9600
Start Bits: 1
Data Bits: 8
Stop Bits: 2
Parity: None

Chapter 5 Maintaining the Analyser

Cleaning the Analyser

The Analyser case can be cleaned with a damp cloth with, if necessary, a small amount of mild detergent. Prevent excessive moisture around the socket panel or in the lead storage area.

Do not allow liquid inside the Analyser or near the sockets. Do not use abrasives, solvents or alcohol.

If any liquid is spilt into the Analyser case, the Analyser should be returned for repair, stating the cause of the defect.

User Maintenance

The Analyser is a rugged quality instrument. However, care should always be taken when using, transporting and storing this type of equipment. Failure to treat the product with care will reduce both the life of the instrument and its reliability.

If the Analyser is subject to condensation, allow the Analyser to completely dry before use.

- Always check the Analyser and all test leads for signs of damage and wear before use.
- Do not open the Analyser under any circumstances.
- Keep the instrument clean and dry.
- Avoid testing in conditions of high electrostatic or electromagnetic fields.
- Maintenance should only be performed by authorised personnel.
- There are no user replaceable parts in the Analyser.
- The unit should be regularly calibrated (at least annually).

For repair or calibration return the instrument to:-

Rigel Medical
Service Dept.,
Seaward Electronic Limited.
Bracken Hill
South West Industrial Estate
Peterlee, Co. Durham
SR8 2SW, England

Tel : +44 (0)191 586 3511
Fax: +44 (0)191 586 0227

sales@rigelmedical.com

calibration@seaward.co.uk

www.seaward.co.uk

www.rigelmedical.com

Prior to returning your unit for service, please contact our service department to obtain a Returns Number.

By obtaining a Returns Number, your service request can be booked in advance thus reducing the down time of your equipment.

When asking for a Returns Number, please quote:

- Instruments name and model
- Serial number
- Service request (ie calibration, repair)

Chapter 6 Accessories

A series of standard and optional accessories are available for the Rigel Medical *Rigel 266 plus* Analyser. The standard accessories are supplied with the Analyser.

Standard Accessories

Accessory	Part Number
Earth Bond Test Lead	286A925
Mains Lead	270A025
Applied Part Adaptor Lead	286A950
Carry Bag	286A951
Manual	286A555
Applied Part Adaptors (5 Off)	274A903

Optional Accessories

Accessory	Part Number
Thermal Printer	283A954
Blue Tooth Adaptor	

Chapter 7 Specifications

Note: Upper current ranges on leakage tests are dependent on when the measurement is taken. If high values of leakage current are present at the start and during the test the Analyser will halt the test to prevent a potential hazardous situation arising to the end user. The upper current range for the tests below is for indication only.

AC Earth Bond Test

Test Voltage.....6V rms nominal (no load)
Test Current.....1A, 10A, 25A
Range 40mΩ - 19.99Ω
Resolution.....0.01Ω
Accuracy..... +/- 5% of reading, +/- 2 digits
Misc.4-wire measurement, floating earth

Insulation Test

Test Voltage500V d.c. nominal (0.5MΩ load)
Short Circuit Current2mA d.c. maximum
Range 100kΩ - 100 MΩ
Resolution.....0.01 MΩ (<100 MΩ)
Accuracy..... +/- 5% of reading, +/- 2 digits (100kΩ - 20MΩ)

Earth Leakage Test

Input Impedance >1Mohm
Frequency Response..... as per IEC 60601-1 requirements
Range 0.04mA – 9.999mA
Accuracy..... +/- 5% of reading, +/- 20μA

Enclosure Leakage Test

Input Impedance >1Mohm
Frequency Response as per IEC 60601-1 requirements
Range 0.04mA – 9.999mA
Accuracy..... +/- 5% of reading, +/- 20µA

Patient Leakage Test

Input Impedance >1Mohm
Frequency Response as per IEC 60601-1 requirements
Range..... 0.004mA – 9.999mA
Accuracy AC..... +/- 5% of reading, +/- 20µA
Accuracy DC..... +/- 5% of reading, +/- 10µA 0.004mA – 1mA dc
..... +/-10% of reading, +/- 10µA >1mA dc

Patient Auxiliary Test

Input Impedance >1Mohm
Frequency Responseas per IEC 60601-1 requirements
Range..... 0.004mA – 9.999mA
Accuracy AC..... +/- 5% of reading, +/- 10µA
Accuracy DC..... +/- 5% of reading, +/- 10µA 0.004mA – 1mA dc
..... +/-10% of reading, +/- 10µA >1mA dc

Patient SIP/SOP Test

Input Impedance >1Mohm
Frequency Response as per IEC 60601-1 requirements
Range..... 0.04mA – 9.999mA
Accuracy..... +/- 5% of reading, +/- 10µA

Patient F-Type Test

SIP/SOP Short Circuit Current Nominal 5mA ac minimum
Current Limiting Resistance Nominal 48K (230V Units)
..... Nominal 24K (110/120V Units)
SIP/SOP Open Circuit Voltage 110% +/-20% of Mains Input Voltage

Patient F-Type Test

Input Impedance >1Mohm
Frequency Response..... as per IEC 60601-1 requirements
Range 0.025mA – 9.999mA
Accuracy..... +/- 5% of reading, +/- 10µA
F-type Short Circuit Current..... Nominal 5mA ac minimum
Current Limiting Resistance Nominal 48K (230V Units)
..... Nominal 24K (110/120V Units)
F-Type Open Circuit Voltage... 110% +/-20% of Mains Input Voltage

Load Test

Measured Load 0.06 - 4kVA (Indication only)
Measured Voltage Mains Supply +/-10%

IEC Lead Test

Test..... 40V a.c., 1mA nominal
Detects..... Good, Open, Short, Reverse

Mechanical

Size 310mm x 210mm x 80mm
Weight4kg

Environmental

Operating 0°C to 40°C (non condensing)

Storage -10°C to 50°C (non condensing)

Maximum R.H 90%

Supply Rating

UK/European/Australian Versions.....230V +/- 10%, 50/60Hz

US Version..... 115V +/- 10%, 50/60Hz

Power Rating..... 30VA

Max EUT Output Current

UK/European Versions 16A

USA/Australian Versions 10A

Appendix

Test Limits

BS EN 60601 (IEC601) Leakage

	Type B Applied Parts		Type BF Applied Parts		Type CF Applied Parts	
	Normal	SFC	Normal	SFC	Normal	SFC
Earth Leakage	0.5mA	1mA	0.5mA	1mA	0.5mA	1mA
Enclosure Leakage	0.1mA	0.5mA	0.1mA	0.5mA	0.1mA	0.5mA
Patient Leakage (dc)	0.01mA	0.05mA	0.01mA	0.05mA	0.01mA	0.05mA
Patient Leakage (ac)	0.1mA	0.5mA	0.1mA	0.5mA	0.01mA	0.05mA
Patient Leakage (F-Type)	----	----	----	5mA	----	0.05mA
Patient SIP/SOP Leakage	----	5mA	----	----	----	----
Patient Auxiliary Leakage (dc)	0.01mA	0.05mA	0.01mA	0.05mA	0.01mA	0.05mA
Patient Auxiliary Leakage (ac)	0.1mA	0.5mA	0.1mA	0.5mA	0.01mA	0.05mA

Earth Bond and Insulation Tests

The following test values are recommended by the Institute of Electrical Engineers as suitable limits for in-service testing in most applications. Note that these are for guidance only, test engineers must use their knowledge and common sense in each practical application.

Earth Bond Continuity Limits

Construction Standard	Resistance between earth pin of plug to earthed metal parts (Ω)
BS EN 60601 Medical Electrical Equipment	0.1 Ohm (excluding power cord) 0.2 Ohm (including power cord)
BS3456 Household electrical appliances	$0.1 + R^*$
BS4533 Luminaires	0.5
BS2769 Hand held motor operated tools	$0.1 + R^*$
BS415 Mains operated electronic and related apparatus	$0.5 + R^*$
BSEN 60950 Information technology equipment	$0.1 + R^*$

* R is the resistance of the mains cable earth wire –cables of 2 metre or less should be less than 0.1Ω

Note that actual readings depend on a good connection to the Earth Bond Clip/Probe and to the Earth Pin.

In-Service Insulation Limits

Construction Standard	Resistance between live parts and the body of a class I appliance (MΩ)	Resistance between live parts and the body of a class II appliance (MΩ)
MDA DB9801	20	-
BS3456 Household electrical appliances	0.5	1.0
BS4533 Luminaires	0.5	1.0
BS2769 Hand held motor operated tools	0.5	1.0
BS415 Mains operated electronic and related apparatus	0.5	1.0
BSEN 60950 Information technology equipment	0.5	1.0
Information technology equipment not constructed to BSEN 60950	May be damaged by insulation tests – use Earth leakage readings	

Copies of the IEE 'Code of Practice for in-service Inspection and Testing of Electrical Equipment' ISBN 0 85296 844 2 may be obtained from:

The Institution of Electrical Engineers
P.O. Box 96
Stevenage,
Herts, SG1 2SD
England

Copies of the Medical Devices Agency 'Checks and tests for newly delivered medical devices' MDA DB9801 Supplement may be obtained from:

Medical Devices Agency
MDA/DTS Orders
Level 9
Hannibal House
Elephant & Castle
London, SE1 6TQ
England